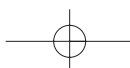
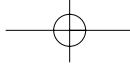


CHAPTER **1**

# Wireless Communications



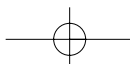


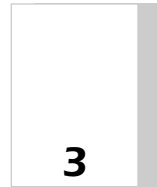
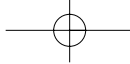
## 1.1 The Amazing Growth of Mobile Communications

Over recent years, telecommunications has been a fast-growing industry. This growth can be seen in the increasing revenues of major telecommunications carriers and the continued entry into the marketplace of new competitive carriers. No segment of the industry, however, has seen growth to match that experienced in mobile communications. From relatively humble beginnings, the last 15 years have seen an explosion in the number of mobile communications subscribers and it appears that growth is likely to continue well into the future.

The growth in the number of mobile subscribers is expected to continue for some years, with the number of mobile subscribers surpassing the number of fixed network subscribers at some point in the near future. Although it may appear that such predictions are optimistic, it is worth pointing out that in the past, most predictions for the penetration of mobile communications have been far lower than what actually occurred. In fact, in several countries, the number of mobile subscribers already exceeds the number of fixed subscribers, which suggests that predictions of strong growth are well founded. It is clear that the future is bright for mobile communications. For the next few years at least, that future means third-generation systems, the subject of this book.

Before delving into the details of third-generation systems, however, it is appropriate to review mobile communications in general, as well as first- and second-generation systems. Like most technologies, advances in wireless communications occur mainly through a process of steady evolution (although there is the occasional quantum-leap forward). Therefore, a good understanding of third-generation systems requires an understanding of what has come before. In order to place everything in the correct perspective, the following sections of this chapter provide a history and a brief overview of mobile communications in general. Chapter 2, “First Generation (1G),” and Chapter 3, “Second Generation (2G),” provide some technical detail on first- and second-generation systems, with the remaining chapters of the book dedicated to the technologies involved in third-generation systems.





## Wireless Communications

# 1.2 A Little History

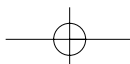
Mobile telephony dates back to 1920s, when several police departments in the United States began to use radiotelephony, albeit on an experimental basis. Although the technology at the time had had some success with maritime vessels, it was not particularly suited to on-land communication. The equipment was extremely bulky and the radio technology did not deal very well with buildings and other obstacles found in cities. Therefore, the experiment remained just an experiment.

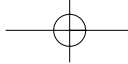
Further progress was made in the 1930s with the development of *frequency modulation* (FM), which helped in battlefield communications during the Second World War. These developments were carried over to peacetime, and limited mobile telephony service became available in the 1940s in some large cities. Such systems were of limited capacity, however, and it took many years for mobile telephone to become a viable commercial product.

### 1.2.1 History of First-Generation Systems

Mobile communications as we know it today really started in the late 1970s, with the implementation of a trial system in Chicago in 1978. The system used a technology known as *Advanced Mobile Phone Service* (AMPS), operating in the 800-MHz band. For numerous reasons, however, including the break-up of AT&T, it took a few years before a commercial system was launched in the United States. That launch occurred in Chicago in 1983, with other cities following rapidly.

Meanwhile, however, other countries were making progress, and a commercial AMPS system was launched in Japan in 1979. The Europeans also were active in mobile communications technology, and the first European system was launched in 1981 in Sweden, Norway, Denmark, and Finland. The European system used a technology known as *Nordic Mobile Telephony* (NMT), operating in the 450-MHz band. Later, a version of NMT was developed to operate in the 900-MHz band and was known (not surprisingly) as NMT900. Not to be left out, the British introduced yet another technology





in 1985. This technology is known as the *Total Access Communications System* (TACS) and operates in the 900-MHz band. TACS is basically a modified version of AMPS.

Many other countries followed along, and soon mobile communications services spread across the globe. Although several other technologies were developed, particularly in Europe, AMPS, NMT (both variants), and TACS were certainly the most successful technologies. These are the main first-generation systems and they are still in service today.

First-generation systems experienced success far greater than anyone had expected. In fact, this success exposed one of the weaknesses in the technologies—limited capacity. Of course, the systems were able to handle large numbers of subscribers, but when the subscribers started to number in the millions, cracks started to appear, particularly since subscribers tend to be densely clustered in metropolitan areas. Limited capacity was not the only problem, however, and other problems such as fraud became a major concern. Consequently, significant effort was dedicated to the development of second-generation systems.

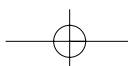
## 1.2.2 History of Second-Generation Systems

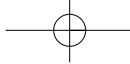
Unlike first-generation systems, which are analog, second-generation systems are digital. The use of digital technology has a number of advantages, including increased capacity, greater security against fraud, and more advanced services.

Like first-generation systems, various types of second-generation technology have been developed. The three most successful variants of second-generation technology are *Interim Standard 136* (IS-136) TDMA, IS-95 CDMA, and the *Global System for Mobile communications* (GSM). Each of these came about in very different ways.

**1.2.2.1 IS-54B and IS-136** IS-136 came about through a two-stage evolution from analog AMPS. As described in more detail later, AMPS is a *frequency division multiple access* (FDMA) system, with each channel occupying 30 KHz. Some of the channels, known as control channels, are dedicated to control signaling and some, known as voice channels, are dedicated to carrying the actual voice conversation.

The first step in digitizing this system was the introduction of digital voice channels. This step involved the application of *time division multiplexing* (TDM) to the voice channels such that each voice channel was





## Wireless Communications

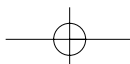
divided into time slots, enabling up to three simultaneous conversations on the same RF channel. This stage in the evolution was known as IS-54 B (also known as Digital AMPS or D-AMPS) and it obviously gives a significant capacity boost compared to analog AMPS. IS-54 B was introduced in 1990.

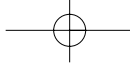
Note that IS-54 B involves digital voice channels only, and still uses analog control channels. Thus, although it may offer increased capacity and some other advantages, the fact that the control channel is analog does limit the number of services that can be offered. For that reason, among others, the next obvious step was to make the control channels also digital. That step took place in 1994 with the development of IS-136, a system that includes digital control channels and digital voice channels.

Today AMPS, IS-54B, and IS-136 are all in service. AMPS and IS-54 operate only in the 800-MHz band, whereas IS-136 can be found both in the 800-MHz band and in the 1900-MHz band, at least in North America. The 1900-MHz band in North America is allocated to *Personal Communications Service* (PCS), which can be described as a family of second-generation mobile communications services.

**1.2.2.2 GSM** Although NMT had been introduced in Europe as recently as 1981, the Europeans soon recognized the need for a pan-European digital system. There were many reasons for this, but a major reason was the fact that multiple incompatible analog systems were being deployed across Europe. It was understood that a single Europe-wide digital system could enable seamless roaming between countries as well as features and capabilities not possible with analog systems. Consequently, in 1982, the *Conference on European Posts and Telecommunications* (CEPT) embarked on developing such a system. The organization established a group called (in French) *Group Spéciale Mobile* (GSM). This group was assigned the necessary technical work involved in developing this new digital standard. Much work was done over several years before the newly created *European Telecommunications Standards Institute* (ETSI) took over the effort in 1989. Under ETSI, the first set of technical specifications was finalized, and the technology was given the same name as the group that had originally begun the work on its development—GSM.

The first GSM network was launched in 1991, with several more launched in 1992. International roaming between the various networks quickly followed. GSM was hugely successful and soon, most countries in Europe had launched GSM service. Furthermore, GSM began to spread outside Europe to countries as far away as Australia. It was clear that GSM





was going to be more than just a European system; it was going to be global. Consequently, the letters GSM have taken on a new meaning—Global System for Mobile communications.

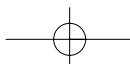
Initially, GSM was specified to operate only in the 900-MHz band, and most of the GSM networks in service use this band. There are, however, other frequency bands used by GSM technology. The first implementation of GSM at a different frequency happened in the United Kingdom in 1993. That service was initially known as DCS1800 since it operates in the 1800-MHz band. These days, however, it is known as GSM1800. After all, it really is just GSM operating at 1800 MHz.

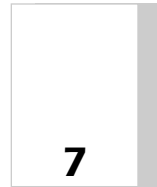
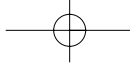
Subsequently, GSM was introduced to North America as one of the technologies to be used for PCS—that is, at 1900 MHz. In fact, the very first PCS network to be launched in North America used GSM technology.

**1.2.2.3 IS-95 CDMA** Although they have significant differences, both IS-136 and GSM use *Time Division Multiple Access* (TDMA). This means that individual radio channels are divided into timeslots, enabling a number of users to share a single RF channel on a time-sharing basis. For several reasons, this technique offers an increase in capacity compared to an analog system where each radio channel is dedicated to a single conversation. TDMA is not the only system that enables multiple users to share a given radio frequency, however. A number of other options exist—most notably *Code Division Multiple Access* (CDMA).

CDMA is a technique whereby all users share the same frequency at the same time. Obviously, since all users share the same frequency simultaneously, they all interfere with each other. The challenge is to pick out the signal of one user from all of the other signals on the same frequency. This can be done if the signal from each user is modulated with a unique code sequence, where the code bit rate is far higher than the bit rate of the information being sent. At the receiving end, knowledge of the code sequence being used for a given signal allows the signal to be extracted.

Although CDMA had been considered for commercial mobile communications services by several bodies, it was never considered a viable technology until 1989 when a CDMA system was demonstrated by Qualcomm in San Diego, California. At the time, great claims were made about the potential capacity improvement compared to AMPS, as well as the potential improved voice quality and simplified system planning. Many people were impressed with these claims and the Qualcomm CDMA system was standardized as IS-95 in 1993 by the U.S. *Telecommunications Industry Associ-*





## Wireless Communications

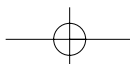
ation (TIA). Since then, many IS-95 CDMA systems have been deployed, particularly in North America and Korea. Although some of the initial claims regarding capacity improvements were perhaps a little overstated, IS-95 CDMA is certainly a significant improvement over AMPS and has had significant success. In North America, IS-95 CDMA has been deployed in the 800-MHz band and a variation known as J-STD-008 has been deployed in the 1900-MHz band.

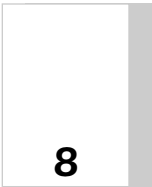
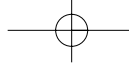
CDMA is unique to wireless mobility in that it spreads the energy of the RF carrier as a direct function of the chip rate that the system operates at. The CDMA system utilizing the Qualcomm technology utilizes a chip rate of 1.228 MHz. The chip rate is the rate at which the initial data stream, the original information, is encoded and then modulated. The chip rate is the data rate output of the PN generator of the CDMA system. A chip is simply a portion of the initial data or message that is encoded through use of a XOR process.

The receiving system also must despread the signal utilizing the exact same PN code sent through an XOR gate that the transmitter utilized in order to properly decode the initial signal. If the PN generator utilized by the receiver is different or is not in synchronization with the transmitter's PN generator, then the information being transmitted will never be properly received and will be unintelligible. Figure 1-1 represents a series of data that is encoded, transmitted, and then decoded back to the original data stream for the receiver to utilize.

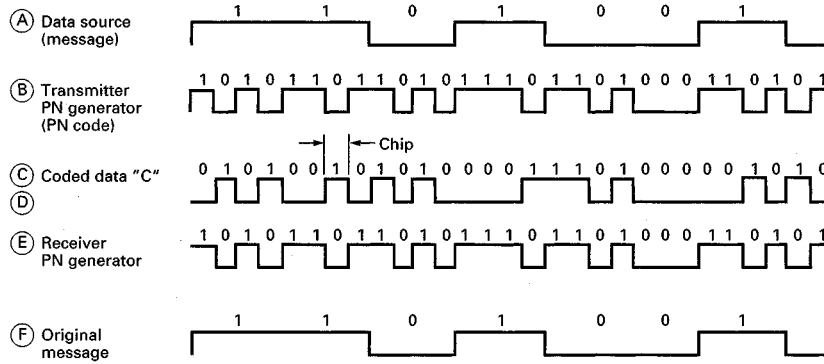
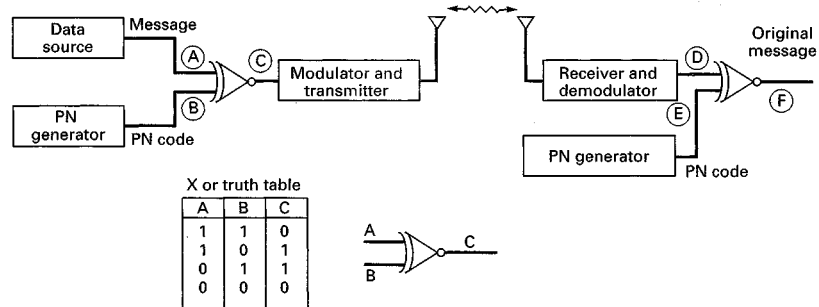
The chip rate also has a direct effect on the spreading of the CDMA signal. Figure 1-2 shows a brief summary of the effects on spreading the original signal that the chosen chip rate has on the original signal. The heart of CDMA lies in the point that the spreading of the initial information distributes the initial energy over a wide bandwidth. At the receiver, the signal is despread through reversing the initial spreading process where the original signal is reconstructed for utilization. When the CDMA signal experiences interference in the band, the despreading process despreads the initial signal for use but at the same time spreads the interference so it minimizes its negative impact on the received information.

The number of PN chips per data bit is referred to as the processing gain and is best represented by the following equation. Another way of referencing processing gain is the amount of jamming, or interference, power that is reduced going through the despreading process. Processor gain is the improvement in the signal-to-noise ratio of a spread spectrum system and is depicted in Figure 1-3.





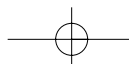
**Figure 1-1**  
CDMA PN coding.

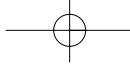


### 1.2.3 The Path to Third-Generation Technology

In many ways, second-generation systems have come about because of fundamental weaknesses in first-generation technologies. First-generation technologies have limited system capacity, they have very little protection against fraud, they are subject to easy eavesdropping, and they have little to offer in terms of advanced features. Second-generation systems are designed to address all of these issues, and they have done a very successful job.

Systems like IS-95, GSM, and IS-136 are much more secure; they also offer higher capacity and more calling features. They are, however, still optimized for voice service and they are not well suited to data communications.



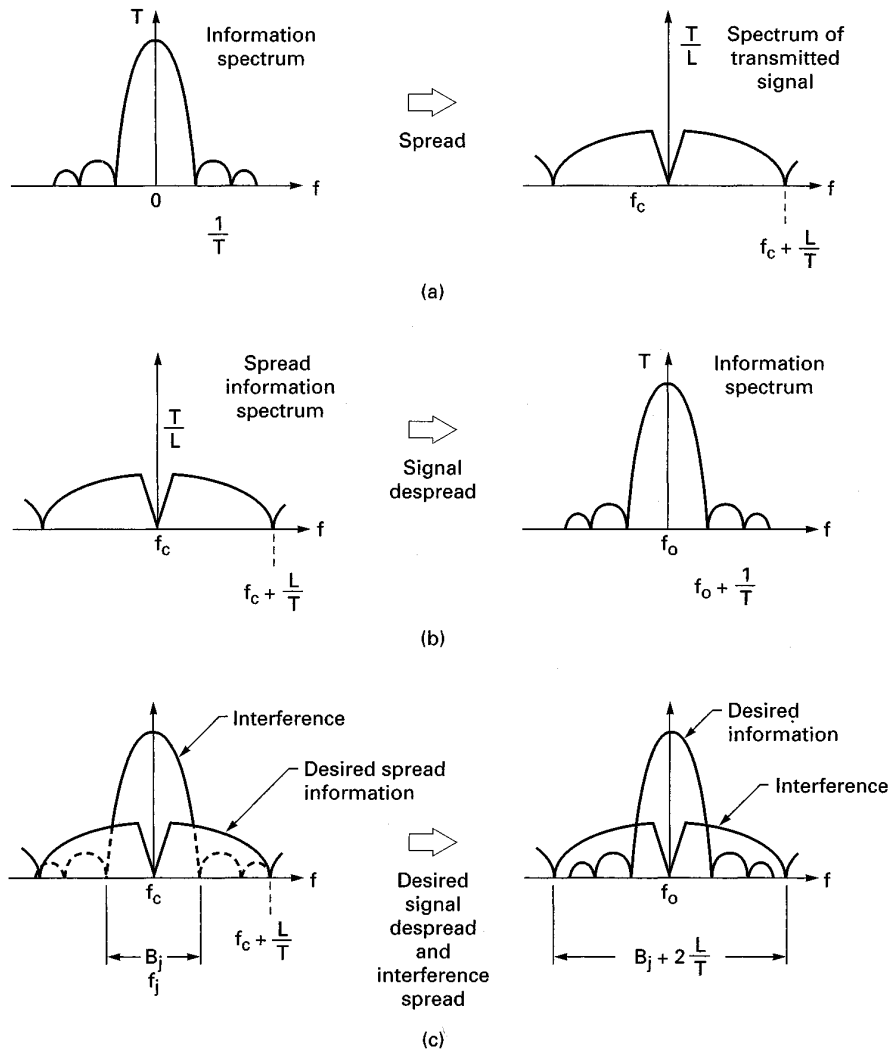


## Wireless Communications

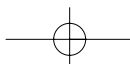
**Figure 1-2**

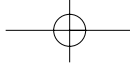
Summary of spread spectrum. (a) Using PN sequence and transmitter with chip (PN) duration of  $T/L$ . (b) using correlation and a synchronized replica of the pn sequence at the receiver. (c) When interface is present.

$L/T$  = chip duration;  
 $f_j$  = jamming frequency;  
 $B_j$  = jammer's bandwidth.



In the current environment of the Internet, electronic commerce, and multimedia communications, limited support for data communications is a serious drawback. Although subscribers want to talk as much as ever, they now want to communicate in a myriad of new ways, such as e-mail, instant messaging, the World Wide Web, and so on. Not only do subscribers want these services, they want mobility too. To provide all of these capabilities means that new advanced technology is required—third-generation technology.



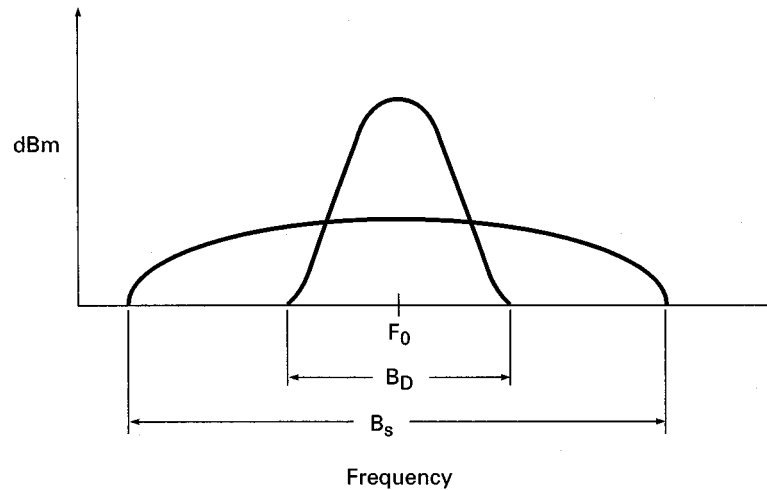
**Figure 1-3**

Processor gain:

$$G_p = \frac{B_s}{B_D}$$

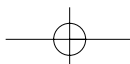
$B_D$  = bandwidth of  
initial signal

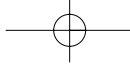
$B_s$  = bandwidth of  
initial signal  
spread



The need for third-generation mobile communications technology was recognized on many different fronts, and various organizations began to address the issue as far back as the 1980s. The *International Telecommunications Union* (ITU) was heavily involved and the work within the ITU was originally known as *Future Public Land Mobile Telecommunications Systems* (FPLMTS). Given the fact, however, that this acronym is difficult to pronounce, it was subsequently renamed *International Mobile Telecommunications—2000* (IMT-2000).

The IMT-2000 effort within the ITU has led to a number of recommendations. These recommendations address areas such as user bandwidth (144 Kbps for mobile service, and up to 2 Mbps for fixed service), richness of service offerings (multimedia services), and flexibility (networks that can support small or large numbers of subscribers). The recommendations also specify that IMT-2000 should operate in the 2-GHz band. In general, however, the ITU recommendations are mainly a set of requirements and do not specify the detailed technical solutions to meet the requirements. To address the technical solutions, the ITU has solicited technical proposals from interested organizations, and then selected/approved some of those proposals. In 1998, numerous air interface technical proposals were submitted. These were reviewed by the ITU, which in 1999 selected five technologies for terrestrial service (non-satellite based). The five technologies are





## Wireless Communications

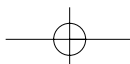
- Wideband CDMA (WCDMA)
- CDMA 2000 (an evolution of IS-95 CDMA)
- TD-SCDMA (time division-synchronous CDMA)
- UWC-136 (an evolution of IS-136)
- DECT

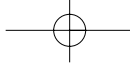
These technologies represent the foundation for a suite of advanced mobile multimedia communications services and are starting to be deployed across the globe. Of these technologies, this book deals with four—WCDMA, CDMA2000, TD-SCDMA, and UWC-136.

## 1.3 Mobile Communications Fundamentals

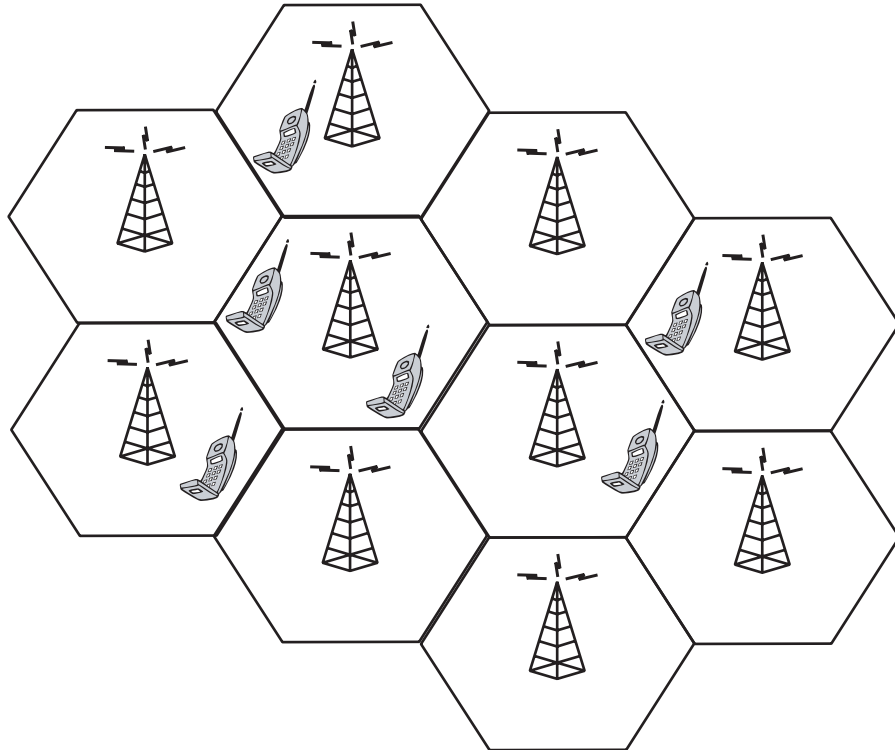
Even though the term “cellular” is often used in North America to denote analog AMPS systems, most, though not all, mobile communications systems are cellular in nature. Cellular simply means that the network is divided into a number of cells, or geographical coverage areas, as shown in Figure 1-4. Within each cell is a base station, which contains the radio transmission and reception equipment. It is the base station that provides the radio communication for those mobile phones that happen to be within the cell. The coverage area of a given cell is dependent upon a number of factors such as the transmit power of the base station, the transmit power of mobile, the height of the base station antennas, and the topology of the landscape. The coverage of a cell can range from as little as about 100 yards to tens of miles.

Specific radio frequencies are allocated within each cell in a manner that depends on the technology in question. In most systems, a number of individual frequencies are allocated to a given cell and those same frequencies are reused in other cells that are sufficiently far away to avoid interference. With CDMA, however, the same frequency can be reused in every cell. Although the scheme shown in Figure 1-4 is certainly feasible and is sometimes implemented, it is common to sectorize the cells, as shown in Figure 1-5. In this approach, the base station equipment for a number of cells is co-located at the edge of those cells, and directional antennas are used to provide coverage over the area of each cell (as opposed to omnidirectional antennas in the case where the base station is located at the center of a



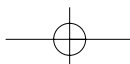


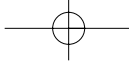
**Figure 1-4**  
Cellular System.



cell). Sectorized arrangements with up to six sectors are known, but the most common configuration is three sectors per base station in urban areas, with two sectors per base station along highways.

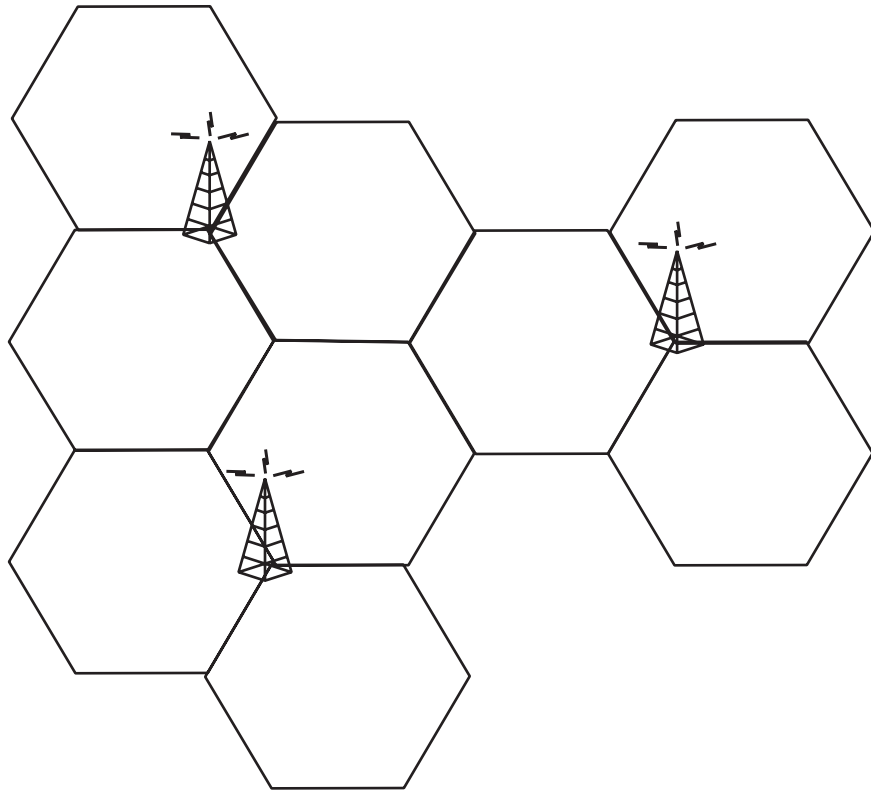
Of course, it is necessary that the base stations be connected to a switching network and for that network to be connected to other networks, such as the *Public Switched Telephone Network* (PSTN) in order for calls to be made to and from mobile subscribers. Furthermore, it is necessary for information about the mobile subscribers to be stored in a particular place on the network. Given that different subscribers may have different services and features, the network must know which services and features apply to each subscriber in order to handle calls appropriately. For example, a given subscriber may be prohibited from making international calls. Should the subscriber attempt to make an international call, the network must disallow that call based upon the subscriber's service profile.



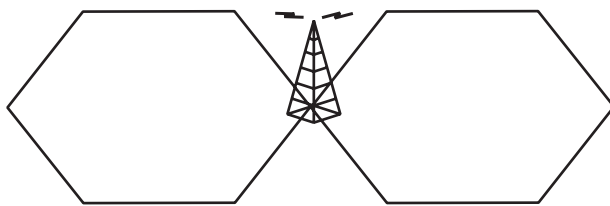


# Wireless Communications

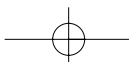
**Figure 1-5**  
Typical Sectorized  
Cell Sites  
(a) Three-sector  
configuration  
(b) Two-sector  
configuration

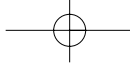


Three-sector configuration



Two-sector configuration



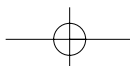
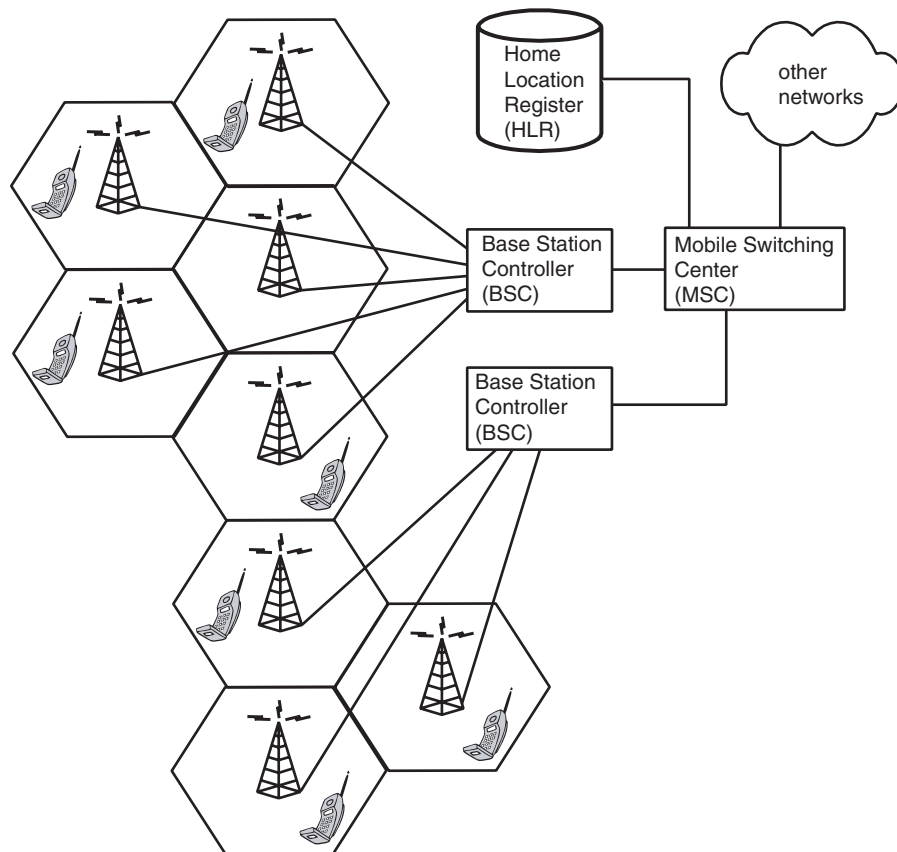


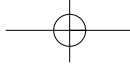
### 1.3.1 Basic Network Architecture

Figure 1-6 shows a typical (although very basic) mobile communications network. A number of base stations are connected to a *Base Station Controller* (BSC). The BSC contains logic to control each of the base stations. Among other tasks, the BSC manages the handoff of calls from one base station to another as subscribers move from cell to cell. Note that in certain implementations, the BSC may be physically and logically combined with the MSC.

Connected to the BSC is the *Mobile Switching Center* (MSC). The MSC, also known in some circles as the *Mobile Telephone Switching Office* (MTSO), is the switch that manages the setup and teardown of calls to and

**Figure 1-6**  
Basic Network  
Architecture.





## Wireless Communications

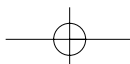
from mobile subscribers. The MSC contains many of the features and functions found in a standard PSTN switch. It also contains, however, a number of functions that are specific to mobile communications. For example, the BSC functionality may be contained with the MSC in certain systems, particularly in first-generation systems. Even if the BSC functionality is not contained within the MSC, the MSC must still interact with a number of BSCs over an interface that is not found in other types of networks. Furthermore, the MSC must contain a logic of its own to deal with the fact that the subscribers are mobile. Part of this logic involves an interface to one or more HLRs, where subscriber-specific data is held.

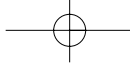
The HLR contains subscription information related to a number of subscribers. It is effectively a subscriber database and is usually depicted in diagrams as a database. The HLR does, however, do more than just hold subscriber data; it also plays a critical role in mobility management—that is, the tracking of a subscriber as he or she moves around the network. In particular, as a subscriber moves from one MSC to another, each MSC in turn notifies the HLR. When a call is received from the PSTN, the MSC that receives the call queries the HLR for the latest information regarding the subscriber's location so that the call can be correctly routed to the subscriber. Note that, in some implementations, HLR functionality is incorporated within the MSC, which leads to the concept of a “home MSC” for a given subscriber.

The network depicted in Figure 1-6 can be considered to represent the bare minimum needed to provide a mobile telephony service. These days, a range of different features' services are offered in addition to just the capability to make and receive calls. Therefore, most of today's mobile communications networks are much more sophisticated than the network depicted in Figure 1-6. As we progress through this book, we will introduce many other network elements and interfaces as we build from the fundamentals to the sophisticated technologies of third-generation networks.

### 1.3.2 Air Interface Access Techniques

Radio spectrum is a precious and finite resource. Unlike other transmission media such as copper or fiber facilities, it is not possible to simply add radio spectrum when needed. Only a certain amount of spectrum is available and it is critical that it be used efficiently, and be reused as much as possible. Such requirements are at the heart of the radio access techniques used in mobile communications.





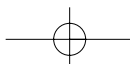
**1.3.2.1 Frequency Division Multiple Access (FDMA)** Of the common multiple access techniques used in mobile communications systems, FDMA is the simplest. With FDMA, the available spectrum is divided into a number of radio channels of a specified bandwidth, and a selection of these channels is used within a given cell. In analog AMPS, for example, the available spectrum is divided into blocks of 30 kHz. A number of 30-kHz channels are allocated to each cell, depending on the expected traffic load for the cell. When a subscriber wants to place a call, one of the 30-kHz channels is allocated exclusively to the subscriber for that call.

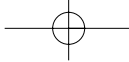
In most FDMA systems, separate channels are used in each direction—from network to subscriber (downlink) and from subscriber to network (uplink). For example, in analog AMPS, when we talk about 30-kHz channels, we are actually talking about two 30-kHz channels, one in each direction. Such an approach is known as *Frequency Division Duplex* (FDD) and normally a fixed separation exists between the frequency used in the uplink and that used in the downlink. This fixed separation is known as the duplex distance. For example, in many systems in North America, the duplex distance is 45 MHz. Thus, in such a system, channel 1 corresponds to two channels (uplink and downlink) with a separation of 45 MHz between them. An FDD FDMA technique can be represented as shown in Figure 1-7.

FDD is not the only duplexing scheme, however. Another technique known as Time Division Duplex is also used. In such a system, only one channel is used for both uplink and downlink transmissions. With TDD, the channel is used very briefly for uplink, then very briefly for downlink, then very briefly again for uplink, and so on. TDD is not very common in North America, but it is widely used in systems deployed in Asia.

**1.3.2.2 Time Division Multiple Access (TDMA)** With *Time Division Multiple Access* (TDMA), radio channels are divided into a number of time slots, with each user assigned a given timeslot. For example, on a given radio frequency, user A might be assigned timeslot number 1 and user B might be assigned time slot number 3. The allocation is performed by the network as part of the call establishment procedure. Thus, the user's device knows exactly which timeslot to use for the remainder of the call, and the device times its transmissions exactly to correspond with the allocated time slot. This technique is depicted in Figure 1-8.

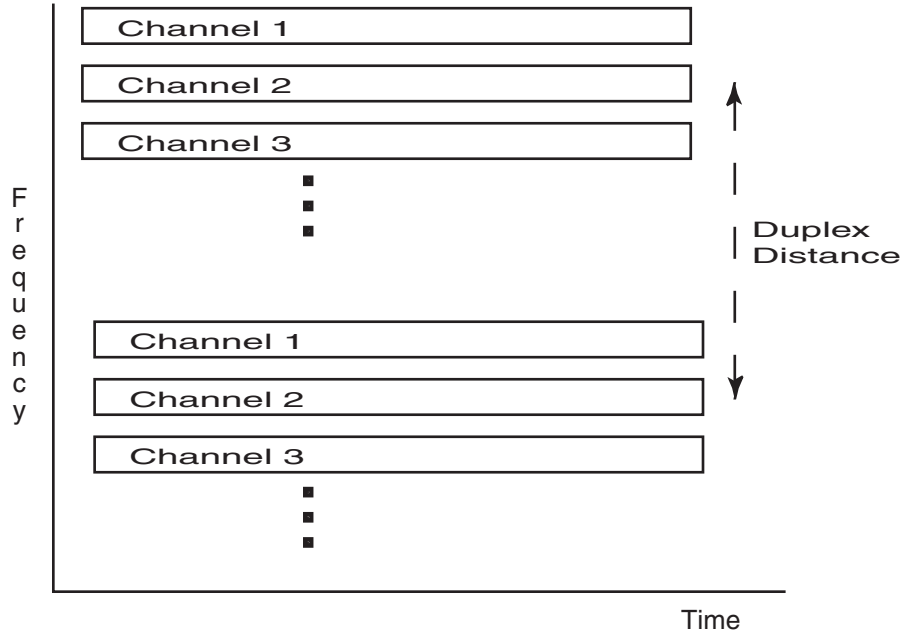
Typically, a TDMA system is also an FDD system, as shown in Figure 1-8, although TDD is used in some implementations. Furthermore, TDMA systems normally also use FDMA. Thus, the available bandwidth is divided into a number of smaller channels as in FDMA and it is these channels that



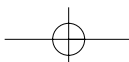
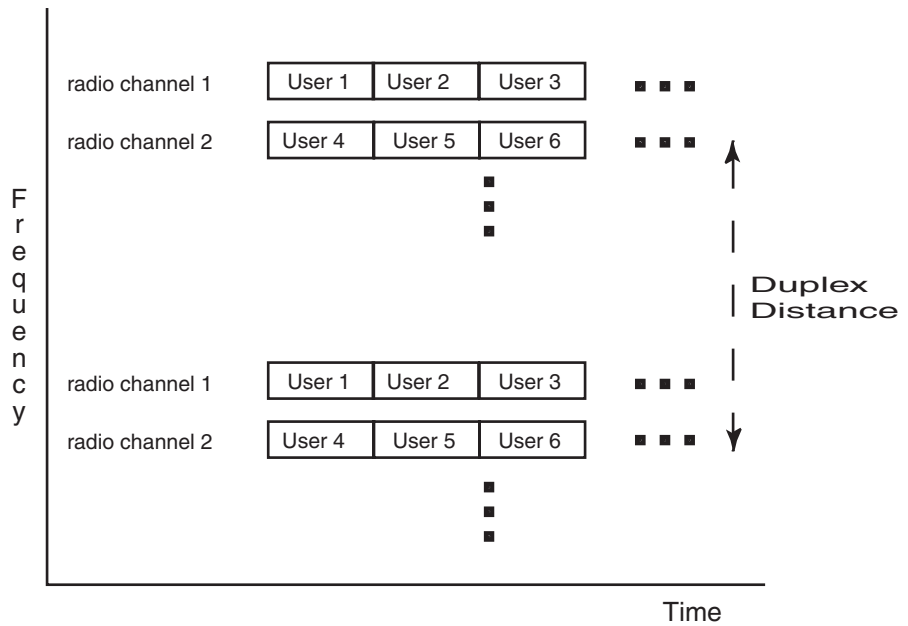


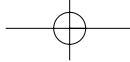
**Wireless Communications**

**Figure 1-7**  
FDMA.



**Figure 1-8**  
TDMA.



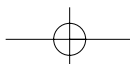


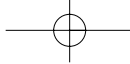
are divided into timeslots. The difference between a pure FDMA system and a TDMA system that also uses FDMA is that, with the TDMA system, a given user does not have exclusive access to the radio channel.

Implementing a TDMA system can be done in many ways. For example, different TDMA systems may have different numbers of time slots per radio channel and/or different time slot durations, and/or different radio channel bandwidths. Although, in the United States, the term TDMA is often used to refer to IS-136, such a usage of the term is incorrect because IS-136 is just one example of a TDMA system. In fact, GSM is also a TDMA system.

**1.3.2.3 Code Division Multiple Access (CDMA)** With CDMA, neither the time domain nor the frequency domain are subdivided. Rather, all users share the same radio frequency at the same time. This approach obviously means that all users interfere with each other. Such interference would be intolerable if the radio frequency bandwidth were limited to just the bandwidth that would be needed to support a single user. To overcome this difficulty, CDMA systems use a technique called spread spectrum, which involves spreading the signal over a wide bandwidth. Each user is allocated a code or sequence and the bit rate of the sequence is much greater than the bit rate of the information being transmitted by the user. The information signal from the user is modulated with the sequence assigned to the user and, at the far end, the receiver looks for the sequence in question. Having isolated the sequence from all of the other signals (which appear as noise), the original user's signal can be extracted.

TDMA systems have a very well-defined capacity limit. A set number of channels and a set number of time slots exist per channel. Once all time slots are occupied, the system has reached capacity. CDMA is somewhat different. With CDMA, the capacity is limited by the amount of noise in the system. As each additional user is added, the total interference increases and it becomes harder and harder to extract a given user's unique sequence from the sequences of all the other users. Eventually, the noise floor reaches a level where the inclusion of additional users would significantly impede the system's capability to filter out the transmission of each user. At this point, the system has reached capacity. Although it is possible to mathematically model this capacity limit, exact modeling can prove a little difficult, since the noise in the system depends on factors such as the transmission power of each individual mobile, thermal noise, and the use of discontinuous transmission (only transmitting when something is being said). By making certain reasonable assumptions in the design phase, however, it is possible to design a





## Wireless Communications

CDMA system that provides relatively high capacity without significant quality degradation.

IS-95/J-STD-008 is the only widely deployed CDMA system for mobile communications. This system uses a channel bandwidth of 1.23 MHz and is an FDD system. The fact that the bandwidth is 1.23 MHz means that the total system bandwidth (typically, 10 MHz, 20 MHz, or 30 MHz) can accommodate several CDMA *radio frequency* (RF) channels. Therefore, like TDMA, IS-95 CDMA also uses FDMA to some degree. In other words, within a given cell, more than one RF channel may be available to system users.

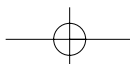
A significant advantage of CDMA is the fact that it practically eliminates frequency planning. Other systems are very sensitive to interference, meaning that a given frequency can be reused only in another cell that is sufficiently far away to avoid interference. In a commercial mobile communications network, cells are constantly being added, or capacity is being added to existing cells, and each such change must be done without causing undue interference. If interference is likely to be introduced, then retuning of part of the network is required. Such retuning is needed frequently and can be an expensive effort. CDMA, however, is designed to deal with interference and, in fact, it allows a given RF carrier to be reused in every cell. Therefore, there is no need to worry about retuning the network when a new cell is added.

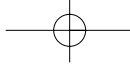
### 1.3.3 Roaming

The discussion so far has focused largely on the methods used to access the network over the air interface. The air interface access is, of course, extremely important. Other aspects, however, are necessary in order to make a wireless communications network a mobile communications network.

Mobility implies that subscribers be able to move freely around the network and from one network to another. This requires that the network tracks the location of a subscriber to a certain accuracy so that calls destined for the subscriber may be delivered. Furthermore, a subscriber should be able to do so while engaged in a call.

The basic approach is as follows. First, when a subscriber initially switches on his or her mobile phone, the device itself sends a registration message to the local MSC. This message includes a unique identification for the subscriber. Based on this identification, the MSC is able to identify the HLR to which the subscriber belongs, and the MSC sends a registration





message to the HLR to inform the HLR of the MSC that now serves the subscriber. The HLR then sends a registration cancellation message to the MSC that previously served the subscriber (if any) and then sends a confirmation to the new serving MSC.

When mobile communications networks were initially introduced, only the air interface specification was standardized. The exact protocol used between the visited MSC and the HLR (or home MSC) was vendor-specific. The immediate drawback was that the home system and visited system had to be from the same vendor if roaming was to be supported. Therefore, a given network operator needed to have a complete network from only one vendor. Moreover, roaming between networks worked only if the two networks used equipment from the same vendor. These limitations severely curtailed roaming.

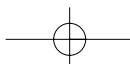
This problem was addressed in different ways on either side of the Atlantic. In North America, the problem was recognized fairly early, and an effort was undertaken to establish a standard protocol between home and visited systems. The result of that effort was a standard known as IS-41. This standard has been enhanced significantly over the years and the current revision of the standard is revision D. IS-41 is used for roaming in AMPS systems, IS-136 systems, and IS-95 systems.

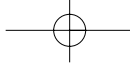
Meanwhile, in Europe, nothing was done to address the roaming issue for first-generation systems, but a major effort was applied to ensuring that the problem was addressed in second-generation technology—specifically GSM. Consequently, when GSM specifications were created, they addressed far more than just the air interface. In fact, most aspects of the network were specified in great detail, including the signaling interface between home and visited systems. The protocol specified for GSM is known as the *GSM Mobile Application Part* (MAP). Like IS-41, GSM MAP has also been enhanced over the years.

Strictly speaking, the term MAP is not specific to GSM. In fact, the term refers to any mobility-specific protocol that operates at layer 7 of the *Open Systems Interconnection* (OSI) seven-layer stack. Given that IS-41 also operates layer 7, the term MAP is also applicable to IS-41.

### 1.3.4 Handoff/Handover

*Handoff* (also known as handover) is the ability of a subscriber to maintain a call while moving within the network. The term handoff is typically used





## Wireless Communications

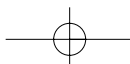
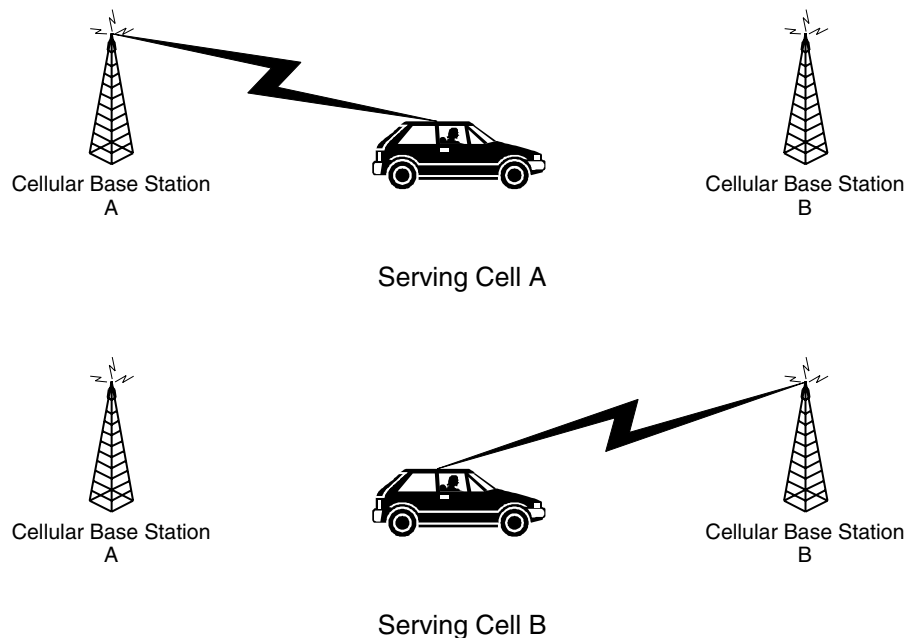
with AMPS, IS-136, and IS-95, while handover is used in GSM. The two terms are synonymous.

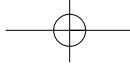
Handoff usually means that a subscriber travels from one cell to another while engaged in a call, and that call is maintained during the transition (ideally without the subscriber noticing any change). In general, handoff means that the subscriber is transitioned from one radio channel (and/or timeslot) to another. Depending on the two cells in question, the handoff can be between two sectors on the same base station, between two BSCs, between two MSCs belonging to the same operator, or even between two networks. (Note that inter-network handoff is not supported in some systems, often mainly for billing reasons.)

It is also possible to handoff a call between two channels in the same cell. This could occur when a given channel in a cell is experiencing interference that is affecting the communication quality. In such a case, the subscriber would be moved to another frequency that is subject to less interference. A handoff scenario is depicted in Figure 1-9.

How does the system determine that a handoff needs to occur? Basically, two main approaches are used. In first-generation technologies, a handoff is

**Figure 1-9**  
Handover.  
(a) Pre-handoff  
(b) Post-handoff





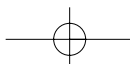
generally controlled by the network. The network measures the signal strength from a mobile as received at the serving cell. If it begins to fall below a certain threshold, then nearby cells are requested to perform signal strength measurements. If a nearby cell records a better signal strength, then it is highly likely that the subscriber has moved to the coverage of that cell. The new cell is instructed by the BSC or MSC (typically just the MSC, since first-generation systems do not have BSCs) to allocate a channel for the subscriber. Once that allocation is performed, the network instructs the mobile to swap to the new channel. This is known as a network-controlled handoff, because the network determines when and how a handoff is to occur.

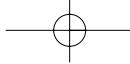
In more recent technologies, a technique known as *mobile assisted handover* (MAHO) is the most common. In the approach, the network provides the mobile with a list of base station frequencies (those of nearby base stations). The mobile makes periodic measurements of the signals received from those base stations (as well as the serving base station), including signal strength and signal quality (usually determined from bit error rates), and it sends the corresponding measurement reports to the network. The network analyzes the reports and makes a determination of if and how a handoff should occur. Assuming that a handoff is required, then the network reserves a channel on the new cell and sends an instruction to the mobile to move to that channel, which it does.

## 1.4 Wireless Migration

In the previous sections of this chapter, some of the various technology platforms were discussed. The existing wireless operators today, regardless of the frequency band or existing technology deployed have or are making very fundamental decisions as to which direction in the 3G evolution they will take. The decision on 3G technology will define a company's position in the marketplace for years to come.

Some existing operators and new entrants are letting the technology platform be defined by the local regulator, thereby eliminating the platform decision. However, the majority of the operators need to determine which platform they must utilize. Since the platforms to pick from utilize different





## Wireless Communications

access technologies, they are by default not directly compatible. The utilization of different access technologies for the realization of 3G also introduces several interesting issues related to the migration from 2G to 3G. The migration path from 2G to 3G is referred to as 2.5G and involves an interim position for data services that are more advanced than 2G, but not as robust as the 3G envisioned data services.

Some of the migration strategies for an existing operator involve

- Overlay
- Spectrum segmentation

The overlay approach typically involves implementing the 2.5 technology over the existing 2G system and then implementing 3G as either an overlay or in a separate part of the radio frequency spectrum they are allocated, spectrum segmentation.

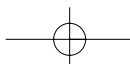
The choice of whether to use an overlay or spectrum segmentation is naturally dependant upon the technology platform that is currently being used, 2G, the spectrum available, the existing capacity constraints, and marketing. Marketing is involved with the decision because of the impact to the existing subscriber base and services that are envisioned to be offered.

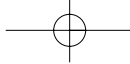
Some of the decisions are rather straightforward involving upgrading portions of the existing technology platforms that are currently deployed. Other operators have to make a decision as to which technology to utilize since they either are building a new system or have not migrated to a 2G platform, using only 1G.

In later chapters various migration strategies are discussed relative to the underlying technology platform that exists.

## 1.5 Harmonization Process

*Harmonization* refers to the vision and objective of the IMT2000 specification that enables the various technology platforms that are defined in that specification to interact with each other. True harmonization relative to the capability of a CDMA2000 and WCDMA system is based on having subscriber units that operate in both technologies. The access infrastructure being able to support both is a goal, but not one that is in the near future.





## 1.6 Overview of Following Chapters

This chapter has served as a brief introduction to mobile communications systems. The brief overview that has been given, however, is certainly not a sufficient background to enable a good understanding of third-generation technology. Therefore, before tackling the details of third-generation systems, it is necessary to better describe first- and second-generation systems. Chapter 2, "First Generation (1G)," addresses first-generation technology and Chapter 3, "Second Generation (2G)," delves into the second-generation systems. The remaining chapters focus on third-generation systems and some of the migration paths to obtainment of the IMT2000 vision.

## References

- AT&T. *Engineering and Operations in the Bell System*, 2nd Ed., AT&T Bell Laboratories, Murry Hill, N.J., 1983.
- Barron, Tim. "Wireless Links for PCS and Cellular Networks," Cellular Integration, Sept. 1995, pgs. 20–23.
- Brewster. *Telecommunications Technology*, John Wiley & Sons, New York, NY, 1986.
- Brodsky, Ira. "3G Business Model," Wireless Review, June 15, 1999, pg. 42.
- Daniels, Guy. "A Brief History of 3G," Mobile Communications International, Issue 65, Oct. 99, pg. 106.
- Gull, Dennis. "Spread-Spectrum Fool's Gold?" Wireless Review, Jan. 1, 1999 pg. 37.
- Homa, Harri, and Antti Toskala. *WCDMA for UMTS*, John Wiley & Sons, 2000.
- Smith, Clint. *Practical Cellular and PCS Design*, McGraw-Hill, 1997.
- Smith, Gervelis. *Cellular System Design and Optimization*, McGraw-Hill, 1996.

